



SUBARU.

GB PART NUMBER: E551SSC000
FR NUMÉRO DE PIÈCE : E551SSC000
IT CODICE PRODOTTO: E551SSC000
DE TEILENUMMER: E551SSC000
ES NÚMERO DE REFERENCIA: E551SSC000

GB DESCRIPTION: Front Underguard
FR DESCRIPTION: Spoiler avant
IT DESCRIZIONE: Protezione del paraurti anteriore
DE BESCHREIBUNG: Vorderer Unterfahrschutz
ES DESCRIPCIÓN: Protección inferior delantera

GB KIT CONTENTS:
FR CONTENU :
IT CONTENUTO DEL KIT:
DE INHALT DES KITS:
ES CONTENIDO DEL JUEGO:

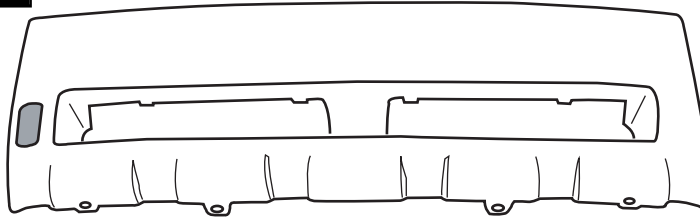
A

x1

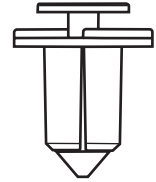
B

x4

C

LARGE ALCOHOL PREP PADS
 Contents: One pad saturated with 70% isopropyl alcohol
 For external use only

x1

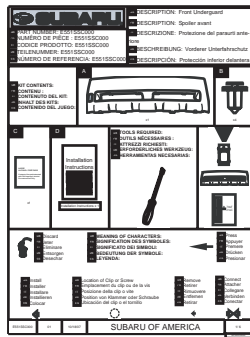
D

GB TOOLS REQUIRED:
FR OUTILS NÉCESSAIRES :
IT ATTREZZI RICHIESTI:
DE ERFORDERLICHES WERKZEUG:
ES HERRAMIENTAS NECESARIAS:

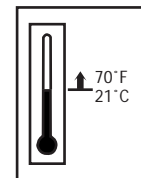
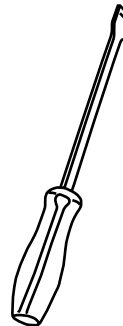

GB Discard
FR Jeter
IT Eliminare
DE Entsorgen
ES Desechar

GB MEANING OF CHARACTERS:
FR SIGNIFICATION DES SYMBOLES:
IT SIGNIFICATO DEI SIMBOLI:
DE BEDEUTUNG DER SYMBOLE:
ES LEYENDA:



GB Press
FR Appuyer
IT Premere
DE Drücken
ES Presionar

GB Install
FR Installer
IT Installare
DE Installieren
ES Colocar

GB Location of Clip or Screw
FR Emplacement du clip ou de la vis
IT Posizione della clip o vite
DE Position von Klammer oder Schraube
ES Ubicación del clip o el tornillo

GB Remove
FR Retirer
IT Rimuovere
DE Entfernen
ES Retirar

GB Connect
FR Attacher
IT Collegare
DE Verbinden
ES Conectar



E551SSC000

01

10/18/07

SUBARU OF AMERICA

1 / 6

SPN0000334

1

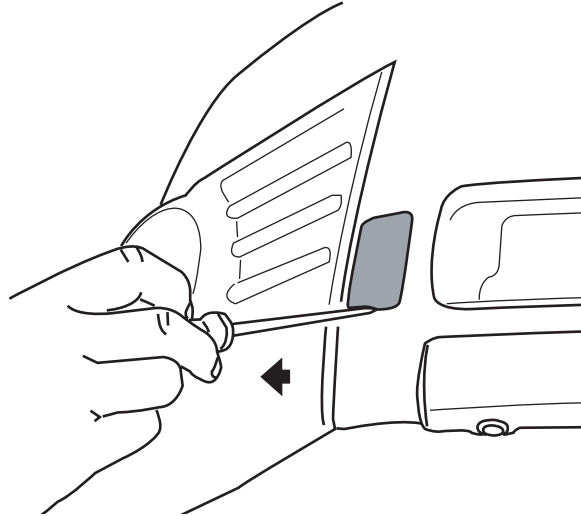
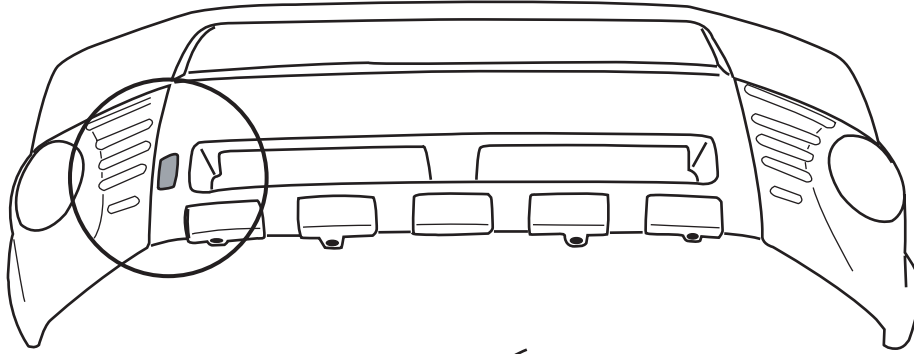

2

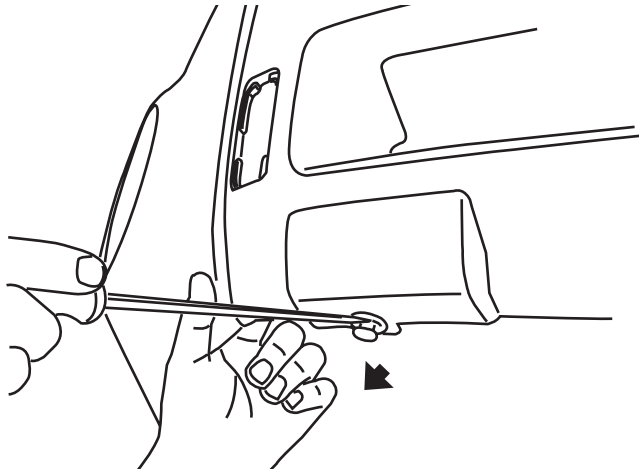
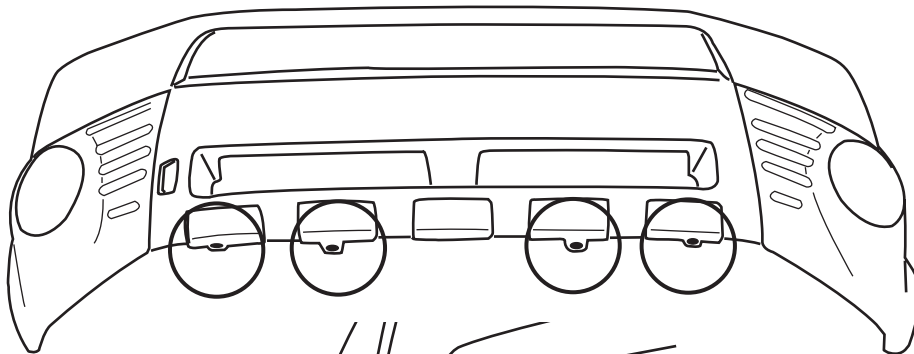

3

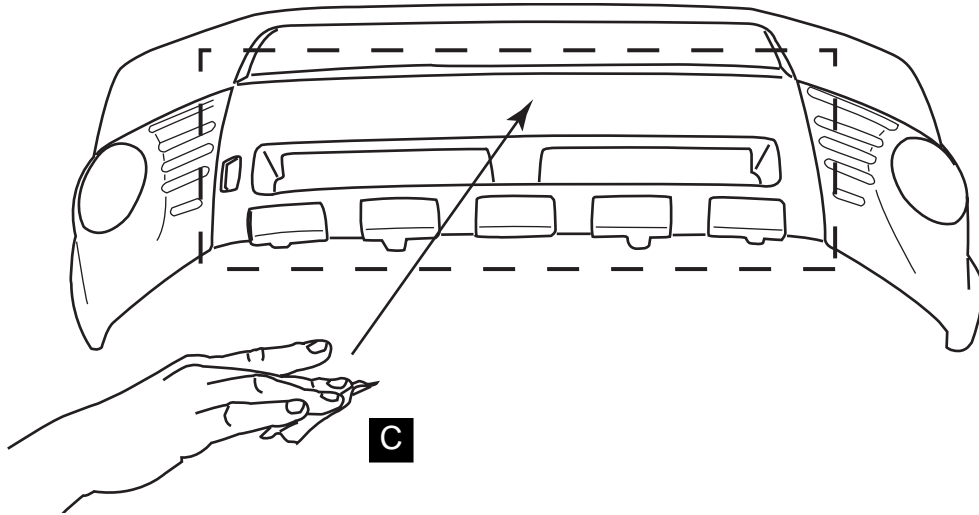

LARGE ALCOHOL PREP PADS
Caution: One pad secured with 70% isopropyl alcohol.
For external use only.

4

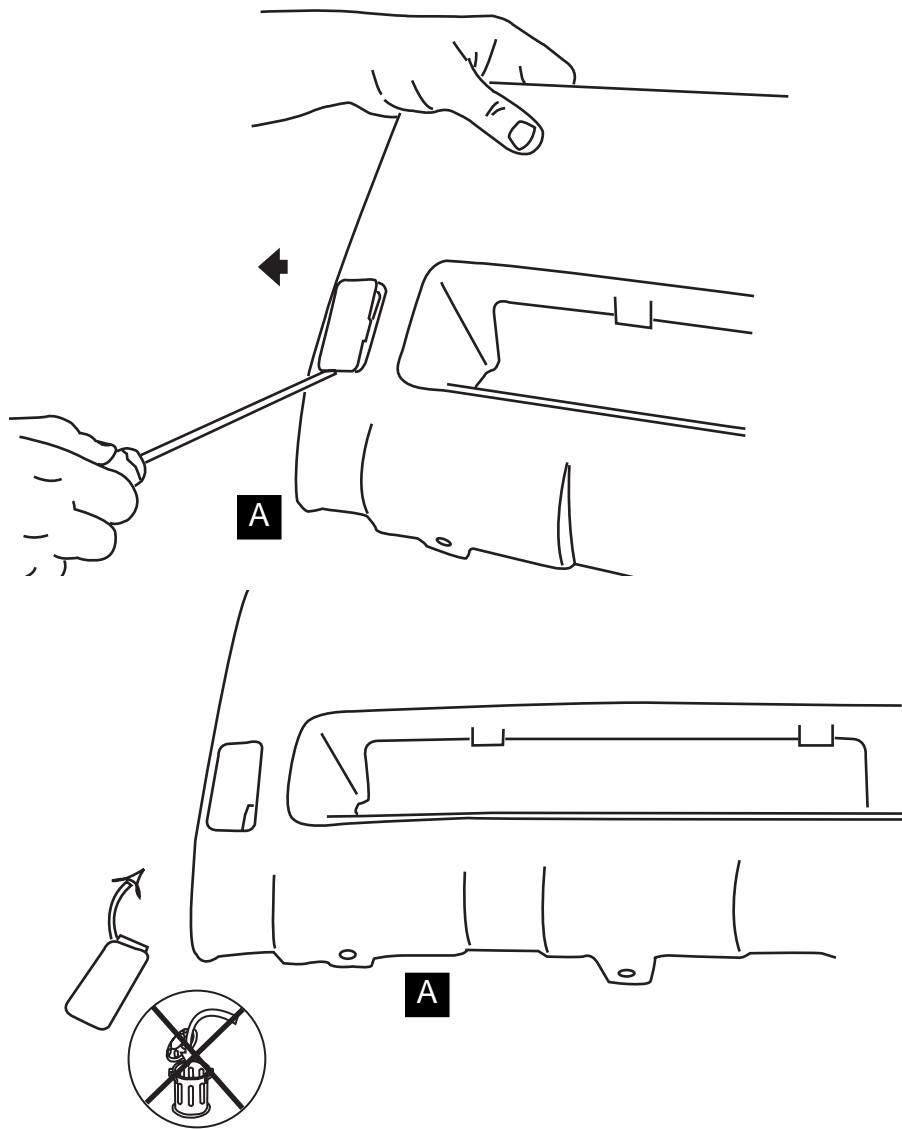

5

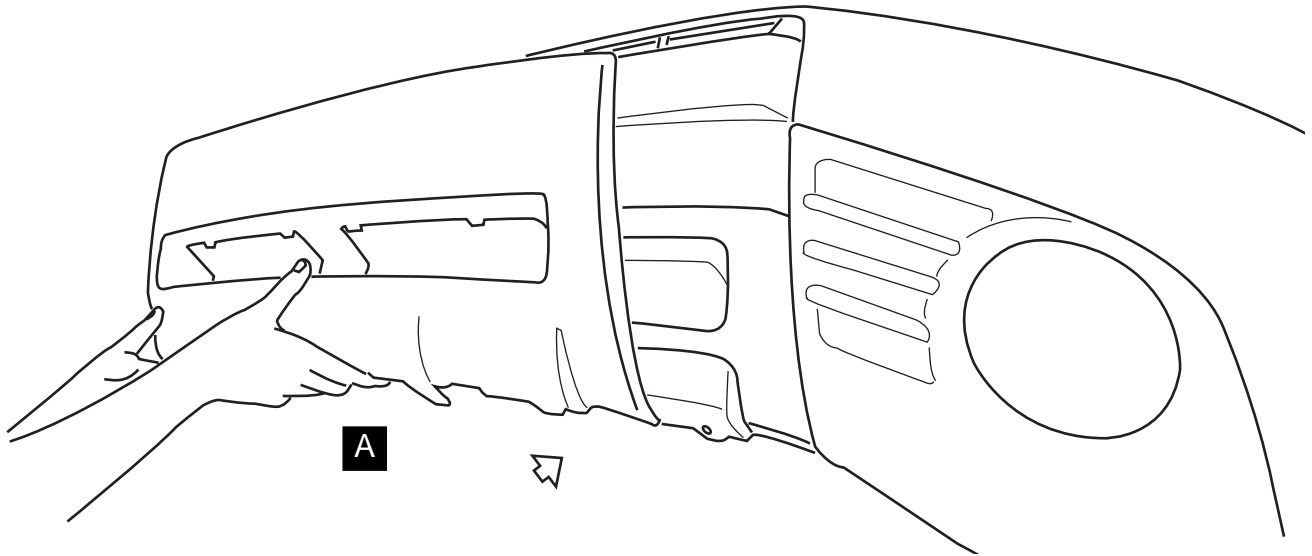

6

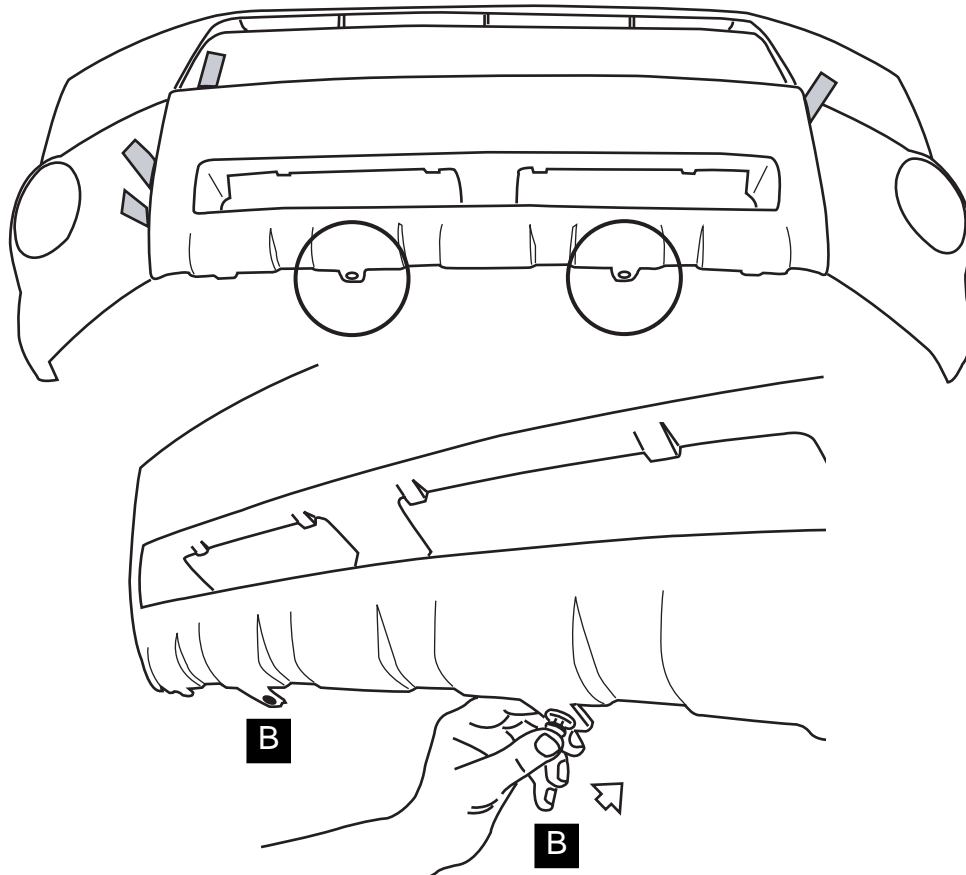

7

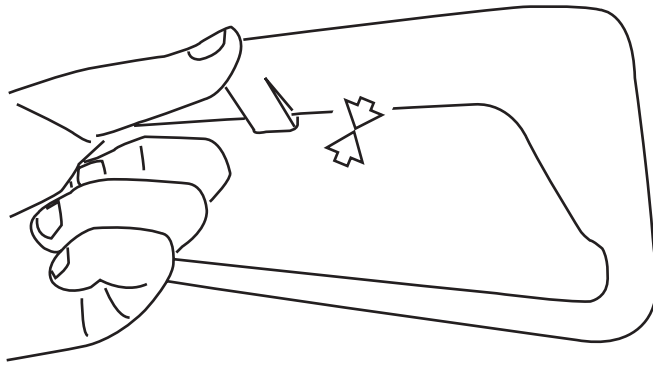
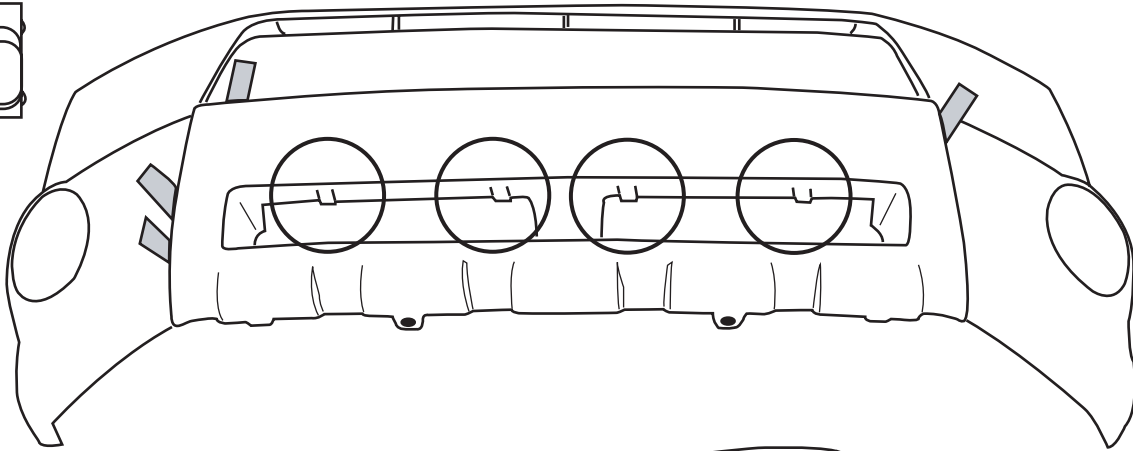

8A

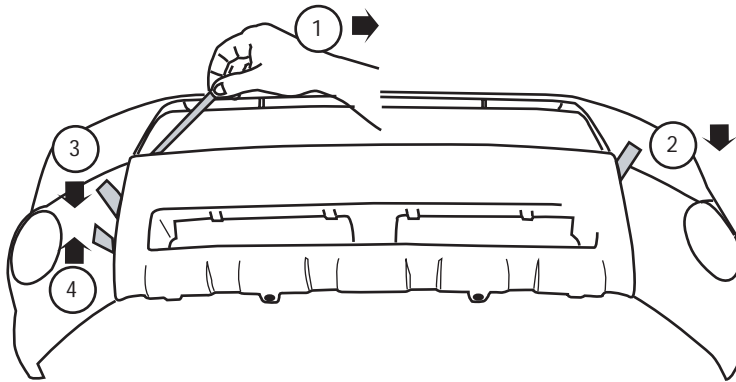

8B

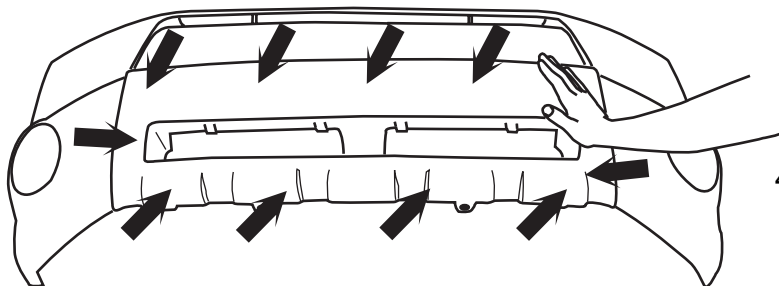

4.5 kg (10 lbs)

- GB** 10 Seconds
- FR** 10 secondes
- IT** 10 secondi
- DE** 10 Sekunden
- ES** 10 segundos

9

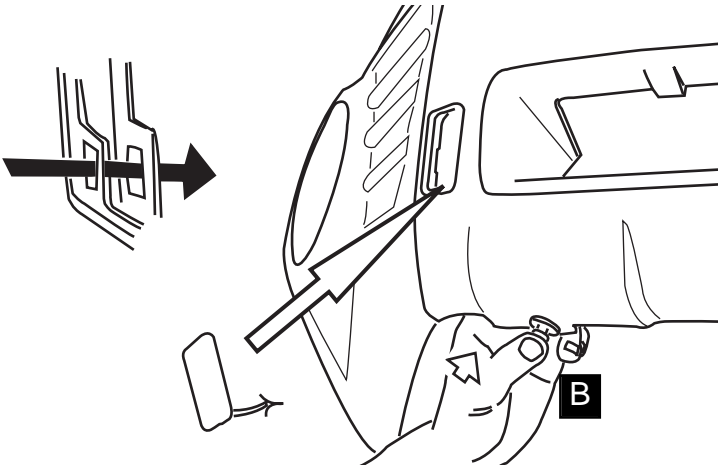
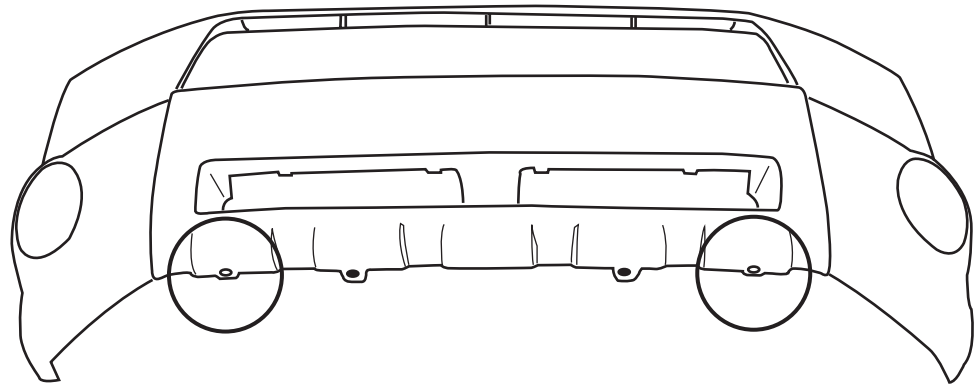

GB Note: Insert anchor into Underguard and Bumper.

FR Remarque : insérer l'ancre dans le spoiler et le pare-chocs.

IT Nota: inserire l'ancoraggio nella protezione del paraurti e nel paraurti.

DE Hinweis: Anker in Unterfahrschutz und Stoßstange einfügen.

ES Nota: insertar el anclaje en la protección inferior y el parachoques.

10

